



COLOUR TELEVISION INSTRUCTIONS

Thank you for buying this JVC colour television.
To make sure you understand how to use your new TV, please read this manual thoroughly before you begin.

L81 series:

AV-21L81

AV-25L81

AV-29L81

L81B series:

AV-21L81B

AV-25L81B

AV-29L81B



Contents

Safety precautions	2
Preparation	3
1 Confirm which remote control you have ...	3
2 Insert the batteries into the remote control ...	3
3 Connecting the aerial and VCR	4
4 Connecting other devices	5
5 Connect the power cord to the AC outlet ...	5
6 Initial setting	6
Basic operation	7
Remote control buttons and functions	8
ECO SENSOR button	8
PICTURE MODE button	8
COLOUR SYSTEM button	8
SOUND SYSTEM button	8
I/II button	9
SUPER BASS button	9
MUTING button	9
DISPLAY button	9
OFF TIMER button	9
RETURN + button	10
CHANNEL SCAN button	10
Using the TV's menus	11
Basic operation	11
INPUT	12
PICTURE TILT	12
VNR	12
COMPRESS (16:9)	12
AUTO SHUTOFF	13
CHILD LOCK	13
BLUE BACK	13
VIDEO-2 SET	14
Picture Adjustments	14
Sound Adjustments	14
MONO SURROUND	15
AI VOLUME	15
AUTO CH PRESET	15
MANUAL CH PRESET	16
SKIP	17
LANGUAGE	17
Attaching the Twin Port Bass Blaster Unit	18
TV buttons and parts	19
Using the buttons on the TV	20
Troubleshooting	21
Specifications	22



Safety precautions

WARNING

- To prevent fire or shock hazard, do not expose the TV to rain or moisture.

CAUTION

- Operate only from the power source indicated on the rear of the TV.
- Avoid damaging the power cord and mains plug. When you unplug the TV, pull it out by the mains plug. Do not pull on the power cord.
- Never block or cover the cabinet openings for ventilation. Never install the TV where good ventilation is unattainable. When installing this TV, leave spaces for ventilation around the TV more than the minimum distances shown in the diagram.
- Do not allow objects or liquid into the cabinet openings.
- In the event of a fault, unplug the TV and call a service technician. Do not attempt to repair it by yourself or remove the rear cover.
- The surface of the TV screen is easily damaged. Be very careful with it when handling the TV. Should the TV screen become soiled, wipe it with a soft dry cloth. Never rub it forcefully. Never use any cleaner or detergent on it.
- When you don't use this TV for a long period of time, be sure to unplug it.

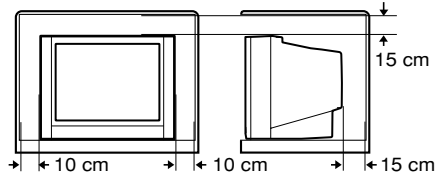

< AV-21L81B and AV-25L81B only >

The Twin Port Bass Blaster Unit is packaged together with the TV.
Before you use the TV, mount the Twin Port Bass Blaster Unit correctly on the TV.

Preparation

1 Confirm which remote control you have

Your TV comes with one of the two remote controls shown below. Functions you can operate differ depending on the type of remote control.

L81 series/AV-29L81B

AV-21L81B/AV-25L81B

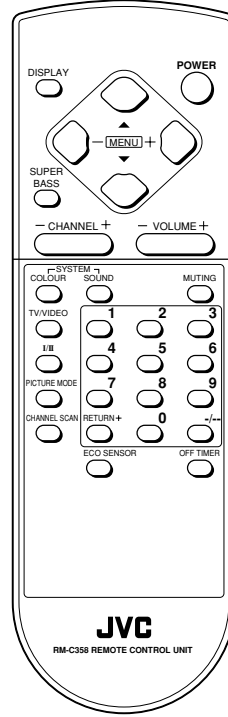
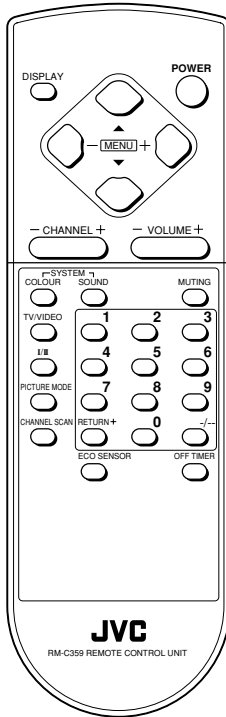

2 Insert the batteries into the remote control

Correctly insert two batteries, observing the ⊕ and ⊖ polarities and inserting the ⊖ end first.

CAUTION:

Follow the cautions printed on the batteries.

Notes:

- Use AA/R6/UM-3 dry cell batteries.
- If the remote control does not work properly, fit new batteries.
The supplied batteries are for testing, not regular use.

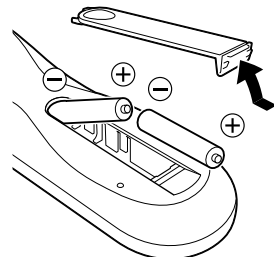

Preparation

3 Connecting the aerial and VCR

- Read the manuals provided with the devices. Depending on the device, the connection method may be different from the diagrams. Also the device settings may need to change depending on the connection method.
- Turn off all the devices including the TV.
- Connecting cables are not supplied.
- When connecting monaural audio to the TV, use the L/MONO jack.
- If you connect the VCR to the TV only with an aerial cable, you should preset the video channel from the VCR to the AV channel (channel number 0) on this TV. See “MANUAL CH PRESET” on page 16 and preset it manually.

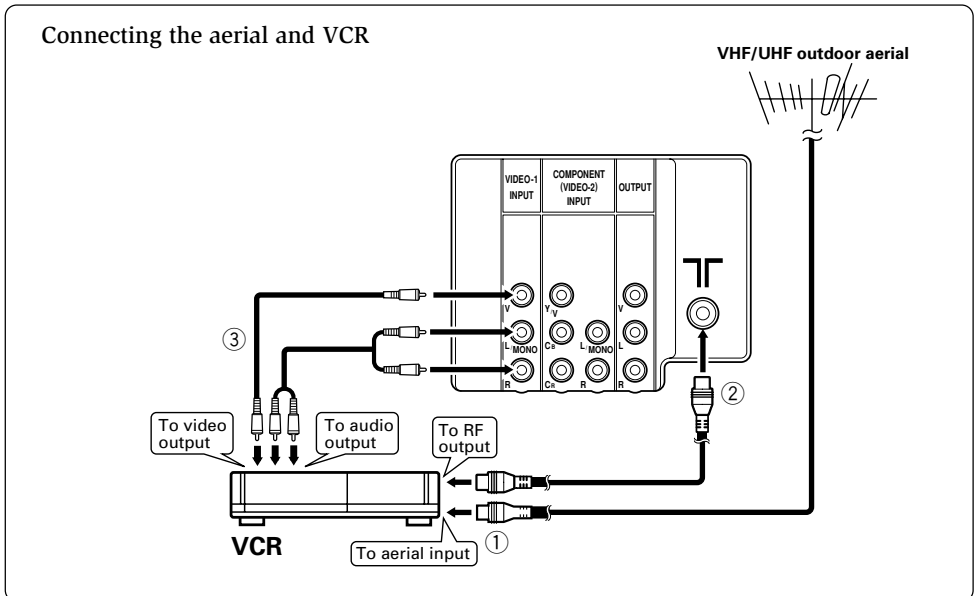
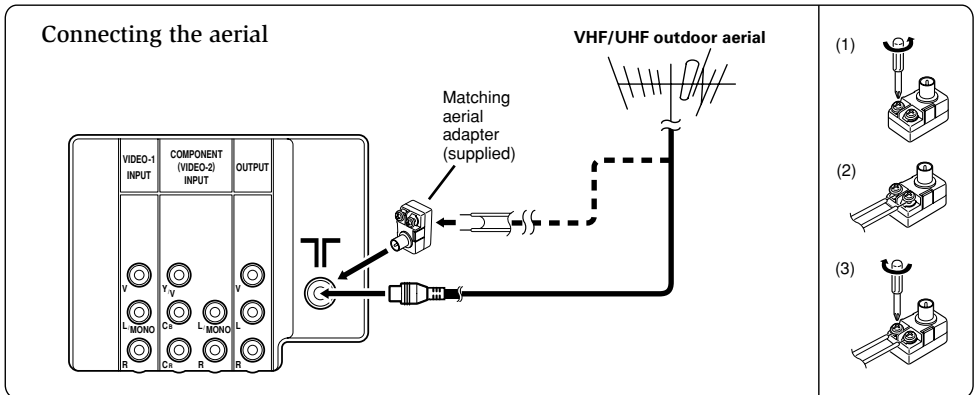

Preparation

4 Connecting other devices

If you are not connecting any other devices, skip step 4 and perform step 5.

- Use the headphones with a stereo mini jack (3.5 mm in diameter). When you connect the headphones, the TV speakers go off.
- The OUTPUT terminal outputs the video and sound signals which you are viewing on the TV. You can dub them onto the VCR connected to the OUTPUT terminal.
(The OUTPUT terminal cannot output component video signals. Also it cannot output any signals when the TV is turned off.)
- Connect components outputting a component signal (Y/C_B/C_R signal), such as a DVD player, to the VIDEO-2 terminal, and set VIDEO-2 SET function to “COMPONENT”. (See page 14.)
- The following illustrations are for the AV-29L81. Your TV’s front and rear pannels may not look exactly like the illustrations.

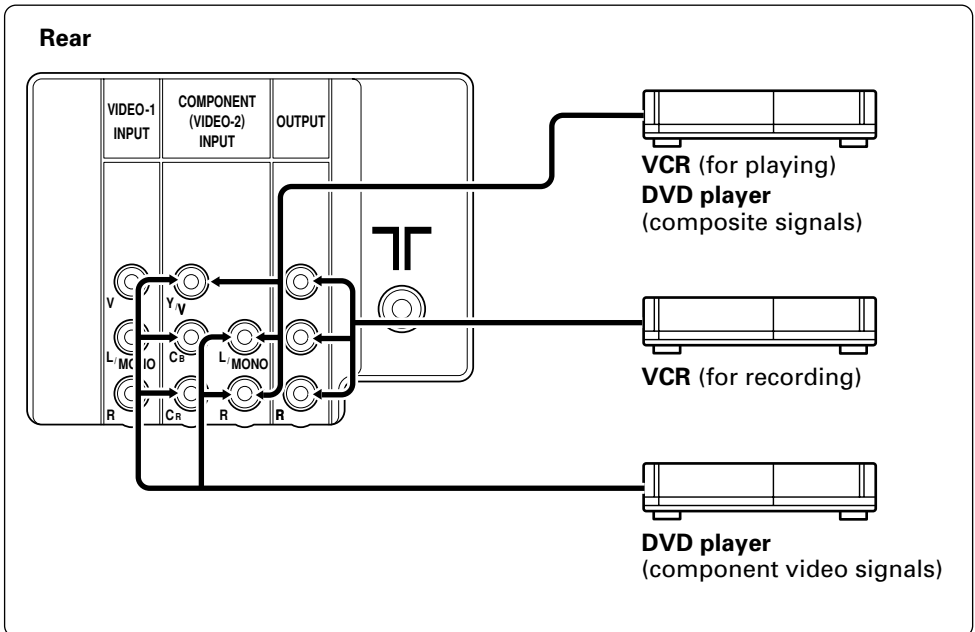
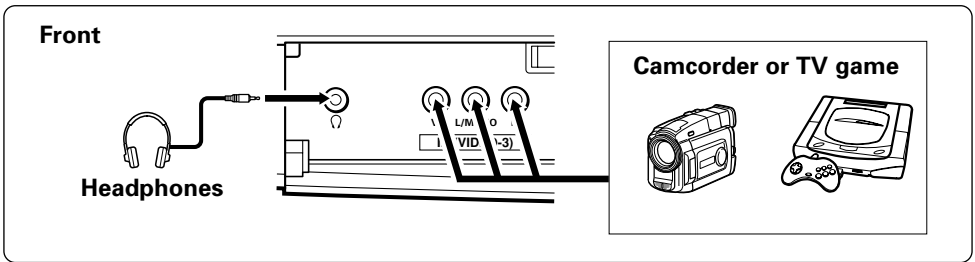

5 Connect the power cord to the AC outlet

Preparation

6 Initial setting

When the TV is first turned on, it enters the initial setting mode, and the JVC logo is displayed. Follow the instructions on the on-screen display to perform the initial settings.

1 Press the Main power button on the TV.

The POWER lamp lights. After the JVC logo has been displayed, the TV automatically switches to the language setting mode.

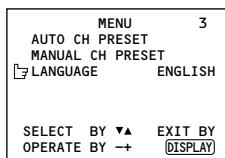

- The JVC logo does not appear if your TV has been turned on once before. In this case, use the LANGUAGE and AUTO CH PRESET functions to perform the initial settings. For details, see pages 15 and 17.

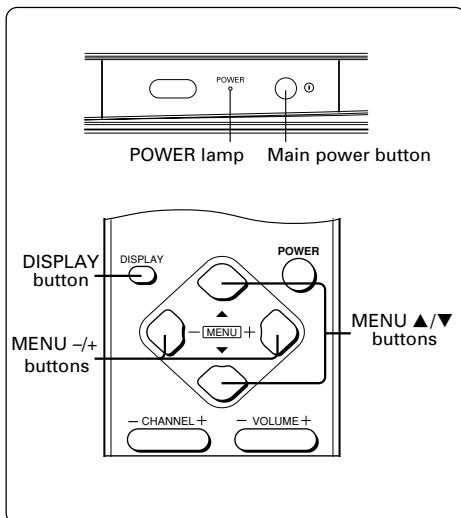

2 Press the MENU -/+ buttons to select language.

3 Press the MENU ▲/▼ buttons to select "AUTO CH PRESET".

4 Press the MENU -/+ buttons to start the AUTO CH PRESET function.

">>> ON SEARCH" is displayed on the screen.

When all the TV channels that can be received on your TV have been preset, the display goes out and the AUTO CH PRESET function operation is completed.

To stop the AUTO CH PRESET function, press the MENU -/+ buttons.

- If a TV channel you want to view is not set to the channel, set it with the MANUAL CH PRESET function. For details, see page 16.

This completes initial setting.

Now you're ready to enjoy your JVC TV.

Basic operation

- The illustration below is for the remote control RM-C359 supplied with L81 series models. Your remote control may not look exactly like the illustrations.

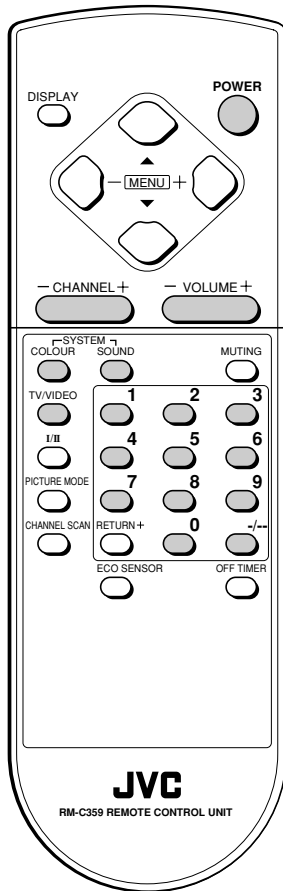

1 Press the **POWER** button to turn your TV on.

- If your TV does not turn on, press the Main power button on the TV then press the POWER button again.
- You can also turn on your TV by pressing any of the following buttons;
 - the CHANNEL $-/+$ button
 - the Number buttons
 - the TV/VIDEO button

2 Select a channel.

- Press the CHANNEL $-/+$ button.
 - Up/down selection cannot be selected for channels to which the SKIP has been set to "YES". See page 17.
- Press the Number buttons to enter the channel number.
 - If you want to enter a two-digit number, press the $-/--$ button to select the two digit mode " $--$ ", then enter the channel number.

3 Press the **VOLUME** $-/+$ button to adjust the sound.

4 To turn your TV off, press the **POWER** button.

- We recommend that you press the Main power button on the TV to turn the main power off if you do not plan to use your TV for a long time or if you wish to save energy.

If the picture is not clear:

Press the COLOUR SYSTEM button to select another colour system, see page 8.

If the sound is not clear:

Press the SOUND SYSTEM button to select another sound system, see page 8.

Viewing Images from an External Device:

Press the TV/VIDEO button to select the VIDEO mode.

- You can also use the INPUT function to select the VIDEO mode. For details, refer to page 12.

Remote control buttons and functions

ECO SENSOR button

You can adjust this TV so that the screen automatically adjusts to the optimum contrast according to the brightness of your room. This function reduces eye strain and the power consumption of this TV.

Press this button to select the desired mode.

DIGITAL ECO SENSOR DISPLAY:

The ECO SENSOR function switches on. In this mode, the clover mark indicating the brightness of your room is displayed for several seconds each time the brightness changes. The number of clover marks displayed on screen increases as your room becomes darker.

DIGITAL ECO SENSOR:

The ECO SENSOR function switches on. However, in this mode, the clover mark will not be displayed.

DIGITAL ECO SENSOR OFF:

The ECO SENSOR function switches off.

PICTURE MODE button

You can select one of three picture adjustment settings as you like.

Press this button to select a mode.

BRIGHT:

Heightens contrast and sharpness.

STANDARD:

Standardizes picture adjustments.

SOFT:

Softens contrast and sharpness.

- Pressing this button returns all the picture settings in "MENU 4" to their default settings.

COLOUR SYSTEM button

If the picture is not clear or no colour appears, change the current colour system to another colour system.

Press this button to select the colour system.

In TV mode:

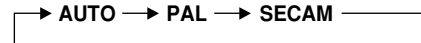

In VIDEO mode:

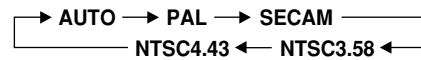

AUTO:

Automatic colour system selection.

- For the colour systems in each country or region, see the table "Broadcasting systems" on page 22.
- If the picture is not normal in the AUTO mode, change the AUTO mode to another colour system.

SOUND SYSTEM button

If the sound is not clear even when the picture appears normal, change the current sound system to another sound system.

Press this button to select the sound system.



- For the sound systems in each country or region, see the table "Broadcasting systems" on page 22.
- You cannot select any sound system when in a VIDEO mode.

Remote control buttons and functions

I/II button

You can select one of the two bilingual sounds in an A2 stereo programme's bilingual programme.

Press this button to select a bilingual sound.

- I : Bilingual I (sub I) sound
- II : Bilingual II (sub II) sound

- The A2 Bilingual function has no effect on stereo programmes of the A2 stereo broadcast programme type, although an A2 Bilingual function indicator will appear on the screen.
- The A2 Bilingual function has no effect on programmes other than A2 stereo broadcast programme types, although an A2 Bilingual function indicator will appear on the screen.
- The A2 Bilingual function has no effect in VIDEO mode, although an A2 Bilingual function indicator will appear on the screen.

SUPER BASS button

< AV-21L81B/AV-25L81B only >

You can enjoy a powerful bass sound by using the SUPER BASS (Super Bass Reflex) function.

Press this button to turn the SUPER BASS function on or off.

- To use this function, you must first mount the Twin Port Bass Blaster Unit packaged with the TV on top of the TV. For details, see page 18.

MUTING button

You can turn the sound off instantly.

Press this button.

To turn the sound on, press this button again.

DISPLAY button

You can continuously display the current channel number or VIDEO mode on the screen.

Press this button.

To turn the display off, press this button again.

- When selecting a VIDEO mode with no signal, indication of the VIDEO mode becomes fixed on the screen.

OFF TIMER button

You can set the TV to automatically turn off after a set time.

Press this button to select the period of time.

- You can set the period of time to a maximum of 120 minutes in 10 minute increments.
- 1 minute before the OFF TIMER function turns off the TV, "GOOD NIGHT!" appears.

To display the remaining time, press this button once.

To cancel the OFF TIMER function, press this button to set the period of time to 0.

- The OFF TIMER function will not turn off the TV's main power.

Remote control buttons and functions

RETURN + button

You can set a channel you frequently view to the Return Channel and you can view that channel at any time with one-touch.

To set the channel to the Return Channel:

- 1 Select the channel you want to set to the Return Channel.**
- 2 Press this button and hold until the message "RETURN PLUS PROGRAMMED!" appears.**
 - When you turn off the TV, the Return Channel setting is cancelled.

To view the Return Channel:

Press this button.

- You can view two channels (current channel and Return Channel) alternately by pressing this button.

To cancel the Return Channel setting:

Press this button and hold until the message "RETURN PLUS CANCELLED!" appears.

If no channel is set to the Return Channel:

You can view the channel selected right before the current channel by pressing this button.

CHANNEL SCAN button

You can quickly view all TV channels programmes that you can view on your TV, and search for the programme you want to view.

1 Press this button to start scanning TV channels.

The TV channel programmes are each displayed for several seconds.

- The programmes of TV channels for which the SKIP function is set to "YES" are not displayed.

2 When you find the programme you want to view, press this button again to stop scanning.

Using the TV's menus

This TV has a number of functions you can operate using the menus. To use all your TV's functions fully, you need to understand how to use the menus.

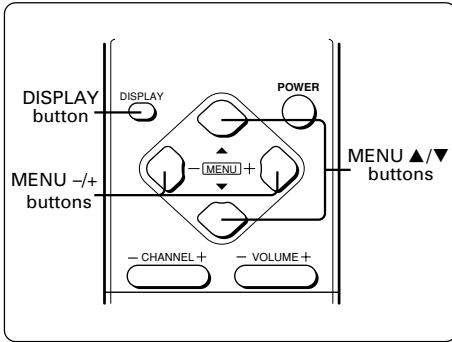

4 Press the MENU +/- buttons to change function settings.

Example:

Changes the AUTO SHUTOFF setting.

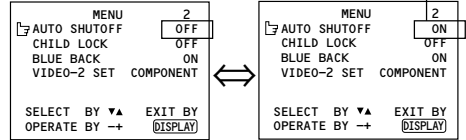

- With some functions, the operation method may differ.

Basic operation

1 Press the MENU ▲/▼ buttons.

One of the 5 menus is displayed.

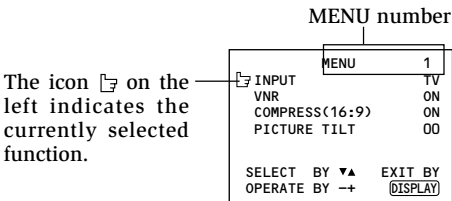

2 Repeatedly press the MENU ▲/▼ buttons to display a desired menu.

- If you hold down the ▼ button, the next menu is displayed.
- If the selected function is on the first line, pressing the ▲ button displays the preceding menu.

3 Repeatedly press the MENU ▲/▼ buttons to select a desired function.

5 Press the DISPLAY button to turn the display off.

- To operate a menu using the buttons on the front panel of the TV, refer to "Operating menus" on page 20.

Using the TV's menus

INPUT

You can view images from VCRs or other devices connected to your TV.

- 1 Press **MENU ▲/▼** to display the "MENU 1" menu, then select "INPUT".

	MENU	1
INPUT		TV
VNR		ON
COMPRESS(16:9)		ON
PICTURE TILT		00
SELECT BY ▼▲ EXIT BY		
OPERATE BY →+ DISPLAY		

- 2 Press **MENU -/+** to select the VIDEO mode.

TV mode changes to VIDEO mode.

PICTURE TILT

< AV-29L81 and AV-29L81B only >

There are cases where the Earth's magnetic force may make the picture tilt. If this happens, you can correct the picture tilt.

- 1 Press **MENU ▲/▼** to display the "MENU 1" menu, then select "PICTURE TILT".

	MENU	1
INPUT		TV
VNR		ON
COMPRESS(16:9)		ON
PICTURE TILT		00
SELECT BY ▼▲ EXIT BY		
OPERATE BY →+ DISPLAY		

- 2 Continue pressing **MENU -/+** until the picture becomes level.

VNR

You can reduce picture noise.

- 1 Press **MENU ▲/▼** to display the "MENU 1" menu, then select "VNR".

	MENU	1
INPUT		TV
VNR		ON
COMPRESS(16:9)		ON
PICTURE TILT		00
SELECT BY ▼▲ EXIT BY		
OPERATE BY →+ DISPLAY		

- 2 Press **MENU -/+** to select "ON".

To cancel the VNR function, select "OFF".

COMPRESS (16:9)

This function converts a normal picture (4:3 aspect ratio) into a wide picture (16:9 aspect ratio).

Use for pictures with a 16:9 aspect ratio that have been squeezed into a normal picture (4:3 aspect ratio), to restore their original dimensions.

- 1 Press **MENU ▲/▼** to display the "MENU 1" menu, then select "COMPRESS (16:9)".

	MENU	1
INPUT		TV
VNR		ON
COMPRESS(16:9)		ON
PICTURE TILT		00
SELECT BY ▼▲ EXIT BY		
OPERATE BY →+ DISPLAY		

- 2 Press **MENU -/+** to select "ON".

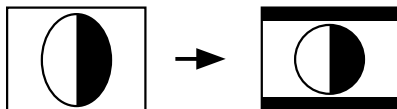

To cancel the COMPRESS (16:9) function, select "OFF".

Using the TV's menus

AUTO SHUTOFF

You can set your TV to turn off if no signals are received for about 15 minutes or longer after the end of a broadcast.

- 1 Press **MENU ▲/▼** to display the "MENU 2" menu, then select "AUTO SHUTOFF".

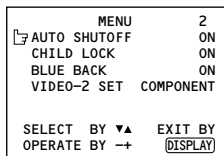

- 2 Press **MENU -/+** to select "ON".

To cancel the AUTO SHUTOFF function, select "OFF".

- The AUTO SHUTOFF function does not turn off the TV's main power.
- The AUTO SHUTOFF will not work for a VIDEO mode.

CHILD LOCK

You can disable the front control buttons of the TV.

When this function is set to "ON", the TV can be operated using only the remote control.

Use this function to prevent children from operating the TV without parental consent.

- 1 Press **MENU ▲/▼** to display the "MENU 2" menu, then select "CHILD LOCK".

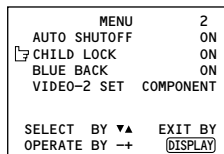

- 2 Press **MENU -/+** to select "ON".

To cancel the CHILD LOCK function, select "OFF".

- The CHILD LOCK function is canceled when you turn the power off.

BLUE BACK

You can mute the sound and change the picture into a blue screen while no signals are received by the TV, or when the signals are unstable.

- 1 Press **MENU ▲/▼** to display the "MENU 2" menu, then select "BLUE BACK".

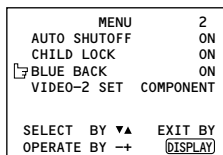

- 2 Press **MENU -/+** to select "ON".

To cancel the BLUE BACK function, select "OFF".

- To view a broadcast even when the reception signal is poor, set the BLUE BACK function to "OFF".
- Even when the BLUE BACK function is set to "OFF", the sound may not be audible.

Using the TV's menus

VIDEO-2 SET

Set the VIDEO-2 SET correctly according to the video signal input from the external device connected to the VIDEO-2 terminal. If this setting is incorrect, images will not be displayed.

- 1 Press **MENU ▲/▼** to display the "MENU 2" menu, then select "VIDEO-2 SET".

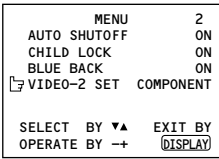

- 2 Set the VIDEO-2 SET according to the video signal input from the VIDEO-2 terminal.

If a normal video signal (composite video signal) is input:

Press the MENU -/+ buttons to select "VIDEO".

If a component video signal (Y/C_B/C_R signals) is input:

Press the MENU -/+ buttons to select "COMPONENT".

Picture Adjustments

You can adjust the picture as you like.

- 1 Press **MENU ▲/▼** to display the "MENU 4" menu.

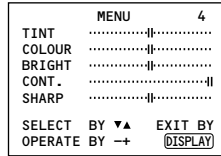

- 2 Press **MENU ▲/▼** to select an item and press **MENU -/+** to adjust it.

TINT*	- : Reddish	+ : Greenish
COLOUR	- : Lighter	+ : Deeper
BRIGHT	- : Darker	+ : Brighter
CONT.	- : Lower	+ : Higher
SHARP	- : Softer	+ : Sharper

* TINT (tint) is displayed only when viewing images from NTSC3.58 or NTSC4.43 colour systems.

Sound Adjustments

You can adjust the sound as you like.

- 1 Press **MENU ▲/▼** to display the "MENU 5" menu.

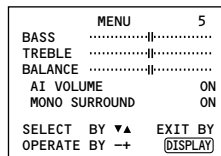

- 2 Press **MENU ▲/▼** to select an item and press **MENU -/+** to adjust it.

TREBLE	- : Weaker	+ : Stronger
BASS	- : Weaker	+ : Stronger
BALANCE	- : Left	+ : Right

Using the TV's menus

MONO SURROUND

You can enjoy normal monaural sound more by converting it into a stereo-like sound.

- 1 Press **MENU ▲/▼** to display the "MENU 5" menu, then select "MONO SURROUND".

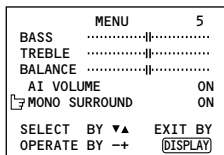

- 2 Press **MENU -/+** to select "ON".

To cancel the MONO SURROUND function, select "OFF".

AI VOLUME

You can prevent the sudden increase or decrease of volume that occurs when changing channels or switching VIDEO modes.

- 1 Press **MENU ▲/▼** to display the "MENU 5" menu, then select "AI VOLUME".

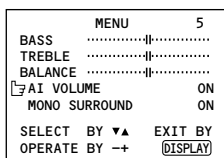

- 2 Press **MENU -/+** to select "ON".

To cancel the AI VOLUME function, select "OFF".

- The AI VOLUME function may not operate as expected if the sound input level from a broadcast station (or video software) is extremely low.
- The AI VOLUME function for TV mode and VIDEO mode can be set separately. For example, you can set it to be off in TV mode and on in VIDEO mode. If you set the AI VOLUME function while viewing a TV channel, the setting is registered as the setting for TV mode. If you set the AI VOLUME function while viewing images from a VIDEO terminal, the setting is registered as the setting for VIDEO mode.

AUTO CH PRESET

You can automatically preset all TV channels that can be received by your TV to channels.

- 1 Press **MENU ▲/▼** to display the "MENU 3" menu, then select "AUTO CH PRESET".

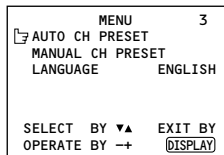

- 2 Press **MENU -/+** to start the AUTO CH PRESET function.

">>> ON SEARCH" is displayed on the screen.

When all the TV channels that can be received on your TV have been preset, the display goes out and the AUTO CH PRESET function operation is completed.

To stop the AUTO CH PRESET:

Press the MENU -/+ button.

- The AUTO CH PRESET function does not preset a TV channel to the AV channel (channel number 0).
- If the TV cannot preset the TV channel you want to view, preset it manually. For details, see "MANUAL CH PRESET" on page 16.

Using the TV's menus

MANUAL CH PRESET

You can manually preset desired TV channels to desired channels.

- 1 Press **MENU ▲/▼** to display the “MENU 3” menu, then select “MANUAL CH PRESET”.

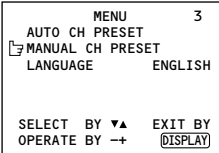

- 2 Press **MENU -/+**.

The sub-menu is displayed.

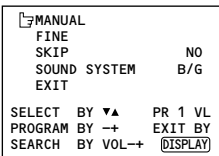

- The channel number is displayed as a PR number. For example, channel 1 will be displayed as PR 1. However, the AV channel will be displayed as AV.

- 3 Press **MENU -/+** to select the channel number.

- 4 Press **VOLUME -/+** to start searching for the TV channel.

“>>>” or “<<<” is displayed on the screen.

When the TV finds a TV channel, the “>>>” or “<<<” display goes out, and the TV channel is preset to the currently selected channel number.

- If the TV channel you want to preset is not displayed, repeat step 4 until the TV finds the TV channel you want to preset.
- To stop the MANUAL CH PRESET function, press any button other than the VOLUME -/+ button.

If the picture is not clear:
Fine-tune the TV channel.

- 1 Press **MENU ▲/▼** to select “FINE”.

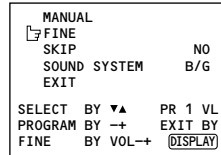

- 2 Hold **VOLUME -/+** down to fine-tune the TV channel so that the best image is displayed on screen.
“>” or “<” indicates that the TV is fine-tuning the TV channel.

If the sound is not clear:

- 1 Press **MENU ▲/▼** to select “SOUND SYSTEM”.

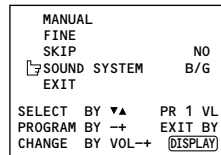

- 2 Press **VOLUME -/+** to select the appropriate sound system.

- For the sound systems in each country or region, refer to the table “Broadcasting systems” on page 22.

- 5 Press **MENU ▲/▼** to select “MANUAL”.

- 6 Repeat steps 3 to 5 if you want to preset another TV channel to a channel.

Using the TV's menus

SKIP

You can set undesired channels to be skipped. Channels set to be skipped cannot be selected by the CHANNEL $-/+$ buttons nor the CHANNEL SCAN button.

- Channels to which TV channels have not been preset are automatically set to be skipped.

1 Press MENU $\blacktriangle/\blacktriangledown$ to display the "MENU 3" menu, then select "MANUAL CH PRESET".

2 Press MENU $-/+$.

The sub-menu is displayed.

3 Press MENU $\blacktriangle/\blacktriangledown$ to select "SKIP".

```
MANUAL
FINE
[SKIP] NO
SOUND SYSTEM B/G
EXIT

SELECT BY  $\blacktriangledown\blacktriangle$  PR 1 VL
PROGRAM BY  $-/+$  EXIT BY
YES/NO BY VOL $-/+$  [DISPLAY]
```

4 Press MENU $-/+$ to select the channel you want to skip.

5 Press VOLUME $-/+$ to select "YES".

The channel is set to be skipped.

To cancel the SKIP function, select "NO".

6 Repeat steps 4 and 5 if you want to set another channel to skip.

LANGUAGE

You can select the language for the on-screen display.

1 Press MENU $\blacktriangle/\blacktriangledown$ to display the "MENU 3" menu, then select "LANGUAGE".

```
MENU 3
AUTO CH PRESET
MANUAL CH PRESET
[LANGUAGE] ENGLISH

SELECT BY  $\blacktriangledown\blacktriangle$  EXIT BY
OPERATE BY  $-/+$  [DISPLAY]
```

2 Press MENU $-/+$ to select language.

The on-screen display indications are in the selected language.

Attaching the Twin Port Bass Blaster Unit

< AV-21L81B and AV-25L81B only >

The Twin Port Bass Blaster Unit is packaged together with the TV. Before you use the TV, mount the Twin Port Bass Blaster Unit correctly on the TV.

Note:

- The SUPER BASS functions do not work unless the Twin Port Bass Blaster Unit is connected correctly to the TV. For details on the SUPER BASS functions, see page 9.

CAUTION:

- The Twin Port Bass Blaster Unit is just placed on top of the TV and is not held in place by a screw. When you use the Twin Port Bass Blaster Unit, pay attention to the following cautions. Otherwise, the Twin Port Bass Blaster Unit or TV may fall over and be damaged, or cause unexpected injury.
 - Do not rest your hands or elbows on the Twin Port Bass Blaster Unit.
 - Do not move the TV with the Twin Port Bass Blaster Unit mounted on top of the TV. Before you move the TV, be sure to remove the Twin Port Bass Blaster Unit.
 - Do not move the TV by holding the Twin Port Bass Blaster Unit.

1 Place the Twin Port Bass Blaster Unit on top of the TV making sure that the mounting pin on the bottom of the Twin Port Bass Blaster Unit fits into the mounting hole on the top of the TV.

- When you mount the Twin Port Bass Blaster Unit, make sure that the mounting pin fits properly into the mounting hole. Otherwise, the Twin Port Bass Blaster Unit may slide off the top of the TV. This may damage the Twin Port Bass Blaster Unit or cause unexpected injury.

2 Firmly insert the Twin Port Bass Blaster Unit connector into the BASS SPEAKER OUT terminal.

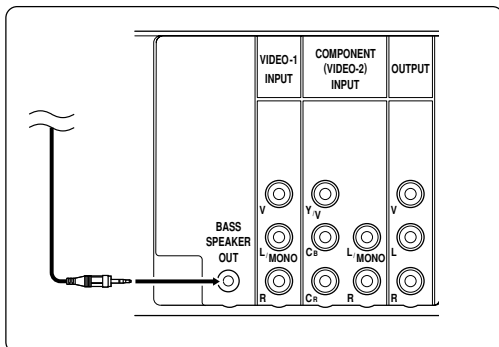
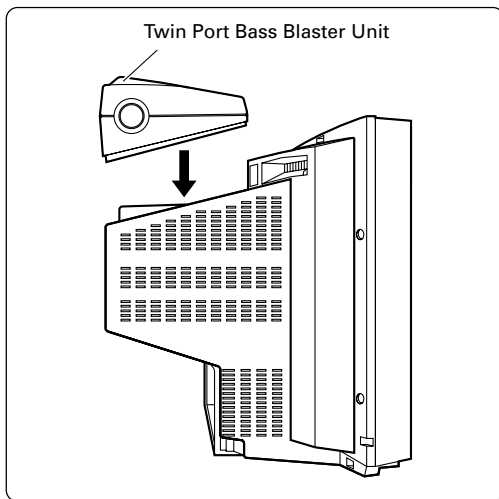

TV buttons and parts

Front

< AV-29 series >

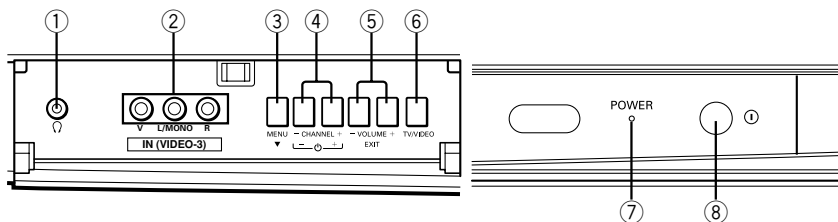

< AV-21 series and AV-25 series >

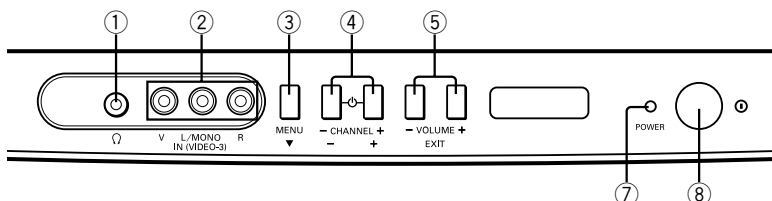

- | | |
|-----------------------|----------------------|
| ① Headphone jack | ⑤ VOLUME +/- buttons |
| ② VIDEO-3 terminal | ⑥ TV/VIDEO button |
| ③ MENU button | ⑦ POWER lamp |
| ④ CHANNEL +/- buttons | ⑧ Main power button |

Rear

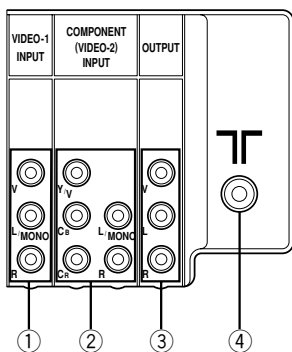

- ① VIDEO-1 INPUT terminal
- ② COMPONENT (VIDEO-2) INPUT terminal
- ③ OUTPUT terminal
- ④ Aerial socket

Using the buttons on the TV

Basic operation

- Check to make sure the CHILD LOCK function is set to “OFF”. When the CHILD LOCK function is set to “ON”, the TV cannot be operated using the front control buttons. For details, see “CHILD LOCK” on page 13.
- 1 Press CHANNEL $-/+$ to turn the TV on from standby mode.
 - 2 Press CHANNEL $-/+$ to select a channel.
 - 3 Press VOLUME $-/+$ to adjust the volume.
 - 4 To turn your TV off, press the Main power button to turn off the TV's main power.

To change the TV mode to the VIDEO mode:

- Press the TV/VIDEO button if the TV has one. See page 7.
- If the TV has no TV/VIDEO button, select the VIDEO mode with the INPUT function in “MENU 1”.

Operating menus

You can operate functions in menus using the front control buttons on the TV.

- 1 Press MENU \blacktriangledown to display a menu.
- 2 Press MENU \blacktriangledown repeatedly to display the menu you want to use.
- 3 Press MENU \blacktriangledown to select the desired function or item.
- 4 Press MENU $-/+$ or VOLUME $-/+$ to carry out the desired operation.
For details, see the description for each function.
- 5 Press VOLUME $-/+$ to turn the menu display off.

To turn the sub-menu display off:

- 1 Press MENU \blacktriangledown to select “EXIT”.

MANUAL		
FINE		
SKIP		NO
SOUND SYSTEM		B/G
\square EXIT		
SELECT	BY \blacktriangledown	PR 1 VL
PROGRAM	BY \rightarrow	EXIT BY
EXIT	BY VOL \rightarrow	(DISPLAY)

- 2 Press VOLUME $-/+$ to turn the display off.

Troubleshooting

If there is no picture or the TV does not operate normally, make sure the problem isn't due to the reasons indicated below.

If the problem persists even after taking the measures indicated, please contact a service technician.

Cannot turn the TV on

- Press the Main power button on the TV.
- Connect the power cord to the AC outlet.

The screen turns blue

- Is the BLUE BACK function on? (see page 13.)

Remote control inoperable

- Replace the batteries. (see page 3.)

Buttons on front of the TV do not work

- Switch the CHILD LOCK function off. (see page 13.)

TV does not respond immediately

- Press the main power button on the TV to turn off the main power. Press the main power button again to turn on the TV. If the TV returns to a normal state, operation is normal.

The TV turns off suddenly

- Is the OFF TIMER function set to operate? (see page 9.)
- Is the AUTO SHUTOFF function on? (see page 13.)

Poor sound

- Press the SOUND SYSTEM button to select another sound system. (see page 8.)
- Adjust the sound settings. (see page 14.)

Poor picture

- Press the COLOUR SYSTEM button to select another colour system. (see page 8.)
- Adjust the picture settings. (see page 14.)
- Is a component signal output device, such as a DVD player, connected correctly? (see page 5.)
- Is the VIDEO-2 SET function setting correct? (see page 14.)
- If noise (snow) totally blocks out the picture, check the following.
 - Have the TV and aerial been connected properly?
 - Has the aerial cable been damaged?
 - Is the aerial pointing in the right direction?
 - Is the aerial itself faulty?
- If the TV or aerial suffer interference from other equipment, stripes or noise may appear in the picture. Move any equipment which can cause interference away from the TV.
- If the TV or aerial suffer interference from signals reflecting from mountains or buildings, double-pictures (ghosting) will occur. Change the aerial's direction or replace it with an aerial with better directionality.
- When a white and bright still image (such as a white dress) is displayed on the screen, the white part may look as if it is coloured. When the image disappears from the screen, the unnatural colours will also disappear.

The picture is tilted

< AV-29L81 and AV-29L81B only >

- A picture may be tilted due to the influence of the earth's magnetism. In this case, use the PICTURE TILT function to adjust the tilt. (see page 12.)

Specifications

TV RF systems

B, G, I, D, K, K1

Colour systems

PAL, SECAM, NTSC 3.58/4.43 MHz (in VIDEO mode only)

Channel and frequencies

VHF low channel (VL), VHF high channel (VH), UHF channel (U)
 Receives cable channels in mid band, super band and hyper band.

External input / output

VIDEO-1: VIDEO input, AUDIO L/R input
 VIDEO-2/COMPONENT: VIDEO input, AUDIO L/R input,
 COMPONENT VIDEO (Y/Cb/Cr) input
 VIDEO-3: VIDEO input, AUDIO L/R input
 OUTPUT: VIDEO output , AUDIO L/R output
 Headphone jack: stereo mini jack (3.5 mm diameter)

Sound-multiplex systems

Bilingual sounds in A2 stereo
 ■Stereo sound in A2 stereo is not available.

Design and specifications subject to change without notice.

Broadcasting systems

Area	Country or Region	System	
		Colour	Sound
Asia, Middle East	Bahrain, Kuwait, Oman, Qatar, United Arab Emirates, Yemen, etc. Indonesia, Malaysia, Singapore, Thailand, India, etc.	PAL	B/G
	China, Vietnam, etc.	PAL	D/K
	Hong Kong, etc.	PAL	I
	Islamic Republic of Iran, Lebanon, Saudi Arabia, etc.	SECAM	B/G
Europe	Russia, etc.	SECAM	D/K
	Czech Republic, Poland, etc.	PAL	D/K
	Germany, Holland, Belgium, etc.	PAL	B/G
	UK, etc.	PAL	I
Oceania	Australia, New Zealand, etc.	PAL	B/G
Africa	Republic of South Africa, etc.	PAL	I
	Nigeria, etc.	PAL	B/G
	Egypt, Morocco, etc.	SECAM	B/G



JVC
VICTOR COMPANY OF JAPAN, LIMITED